

Article number: 0106083

Description: Retaining ring JV 72

## Measures

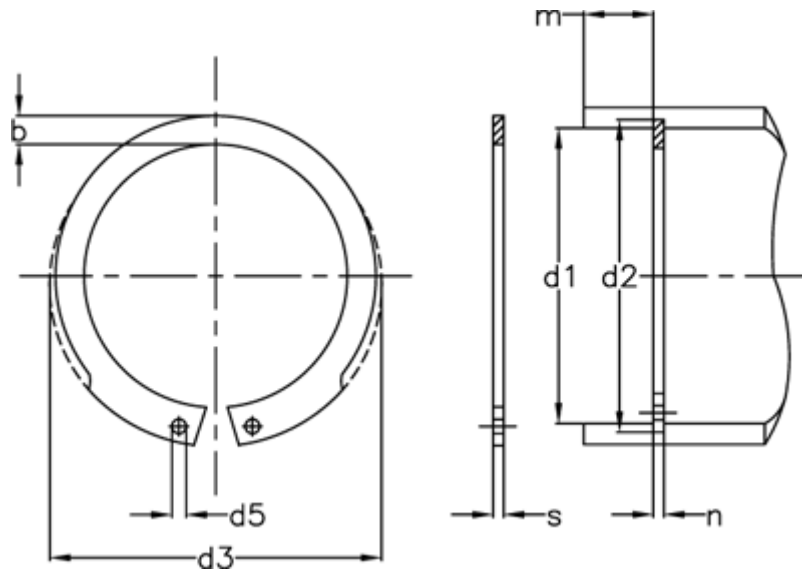

AN mm <sup>2</sup>	= 173	FRg kN	= 2.5	tol	= 0.3
b	= 6.0	FR kN	= 119.0	tol	= -0.07
d1	= 72	g	= 2.5	tol	= +1,10-0,46
d2	= 75.0	K kN-mm	= 214.0	tol	= +0,30
d3	= 76.5	m min	= 2.65	Tong	= ZGJ-3
d5 min	= 2.5	Nominal drive	= 4.5	Weight kg/1000	= 19.60
Description	= JV 72	s	= 2.50		
FN kN	= 28.80	t	= 1.50		